

Ventilation Louvres

A-3200 | Technical Datasheet



 www.c-sgroup.co.uk/2393

STANDARD DETAIL

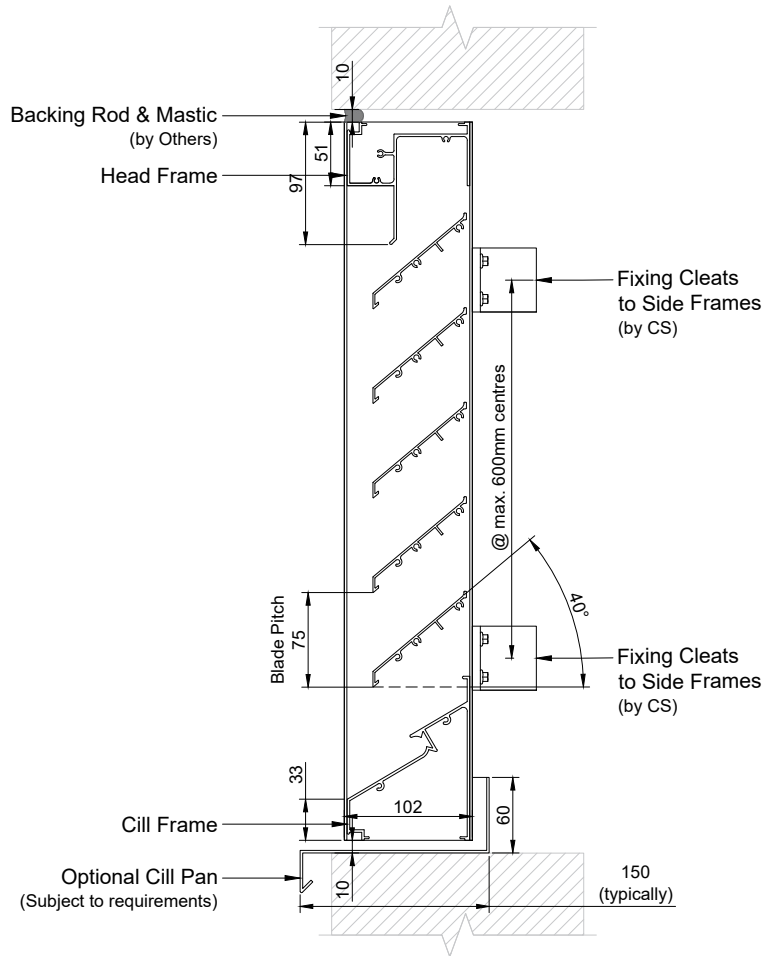

SECTION ON ELEVATION (1:6 @A4)

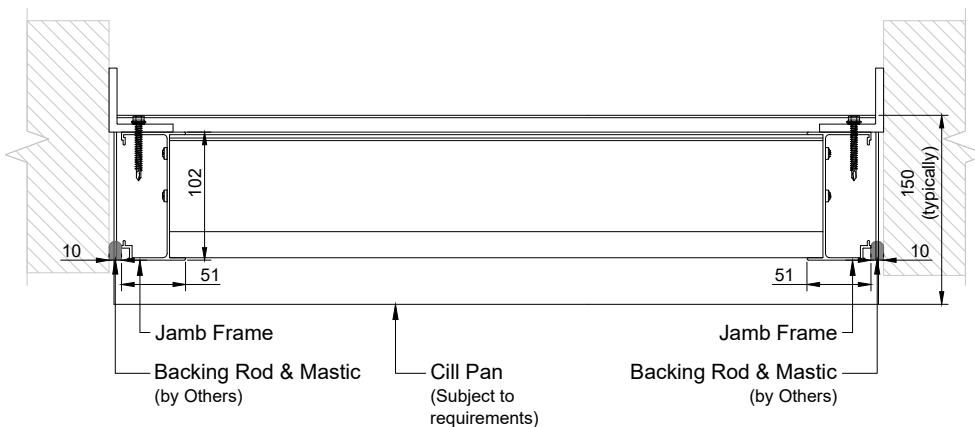

PLAN VIEW (1:6 @A4)

STANDARD DETAIL

With Insect Mesh or Bird Guard

INSECT MESH

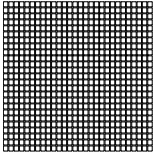

Fiberglass Mesh
Black PVC coated
(1:2 @A4)
LV-1008
72% Free Area

BIRD/ VERMIN GUARDS

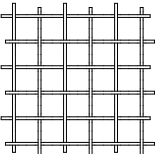

Galvanized Welded Mesh - (Standard)
(1:4 @A4)
LV-1408
85% Free Area

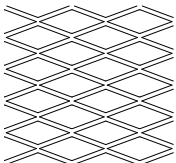

Flattened Aluminium
38-85AF - (Option)
(1:4 @A4)
LV-0158
73% Free Area

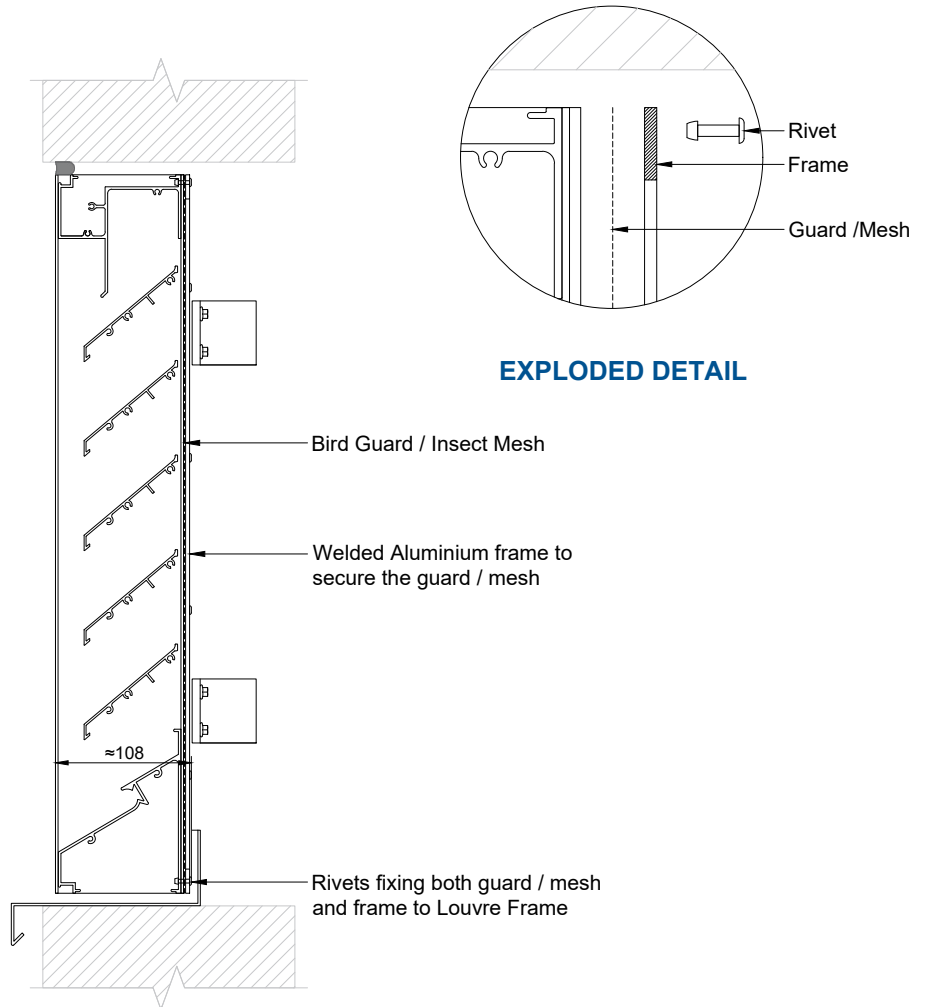

SECTION ON ELEVATION (1:6 @A4)

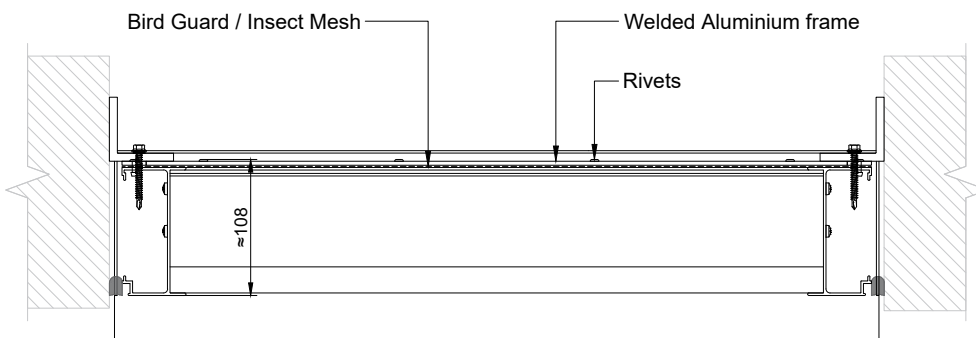

PLAN VIEW (1:6 @A4)

All dimensions in millimeters unless otherwise stated. Do not scale from the drawing.

STANDARD DETAIL

With Single Skin Blanking Panel

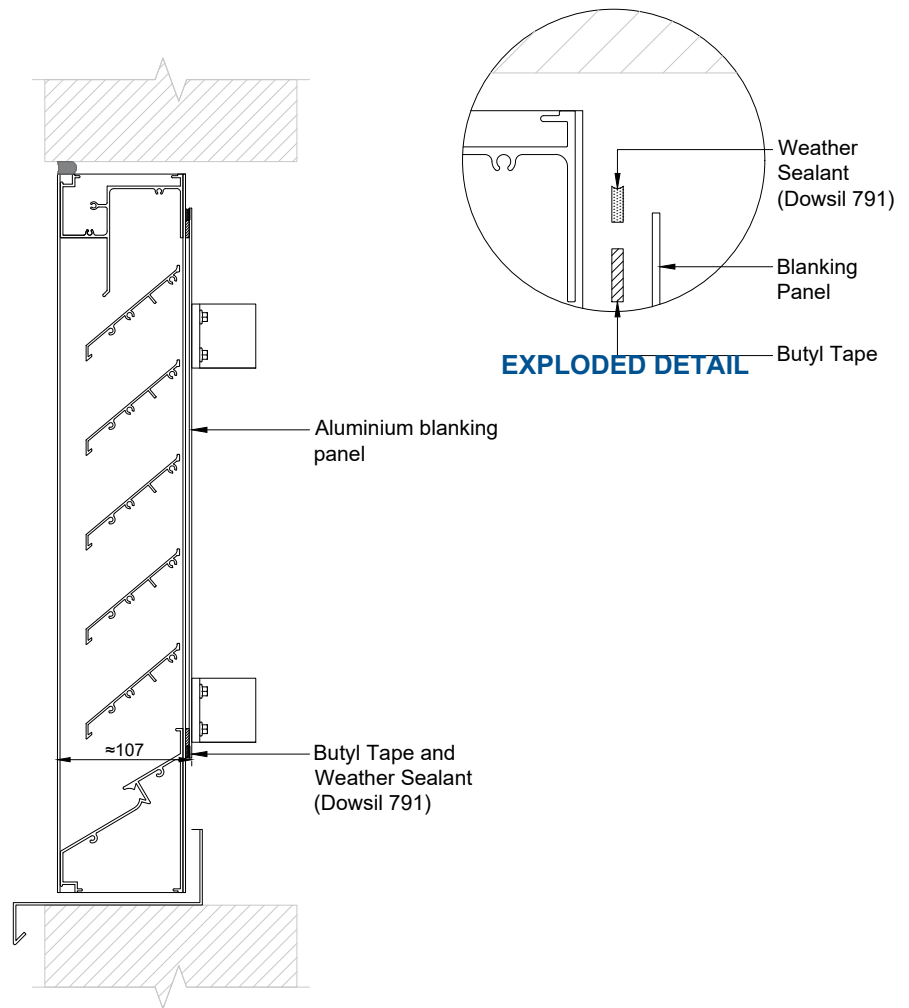

SECTION ON ELEVATION (1:6 @A4)

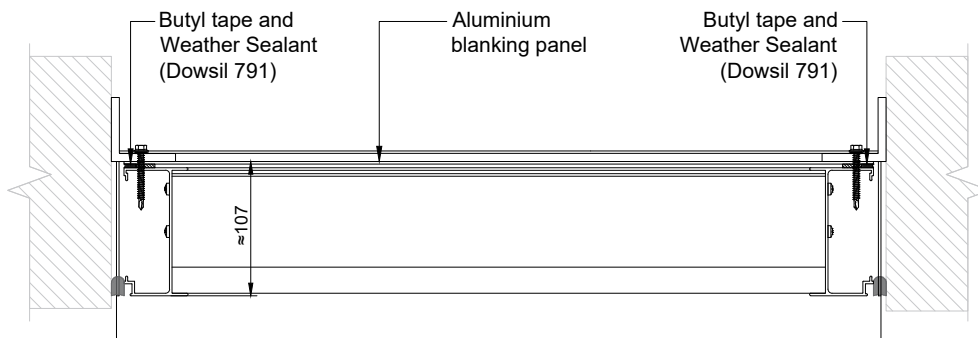

PLAN VIEW (1:6 @A4)

All dimensions in millimeters unless otherwise stated. Do not scale from the drawing.

Ventilation Louvres

A-3200 | Technical Datasheet

STANDARD DETAIL

With Insulated Blanking Panel

NOTE:

Insulation material options include:

- Non-combustible, A1 classified (to EN 13501-1) high strength stone wool core faced with open filament net
- Extruded polystyrene core

Panel thicknesses will vary, depending on the chosen core type and project's insulation requirements.

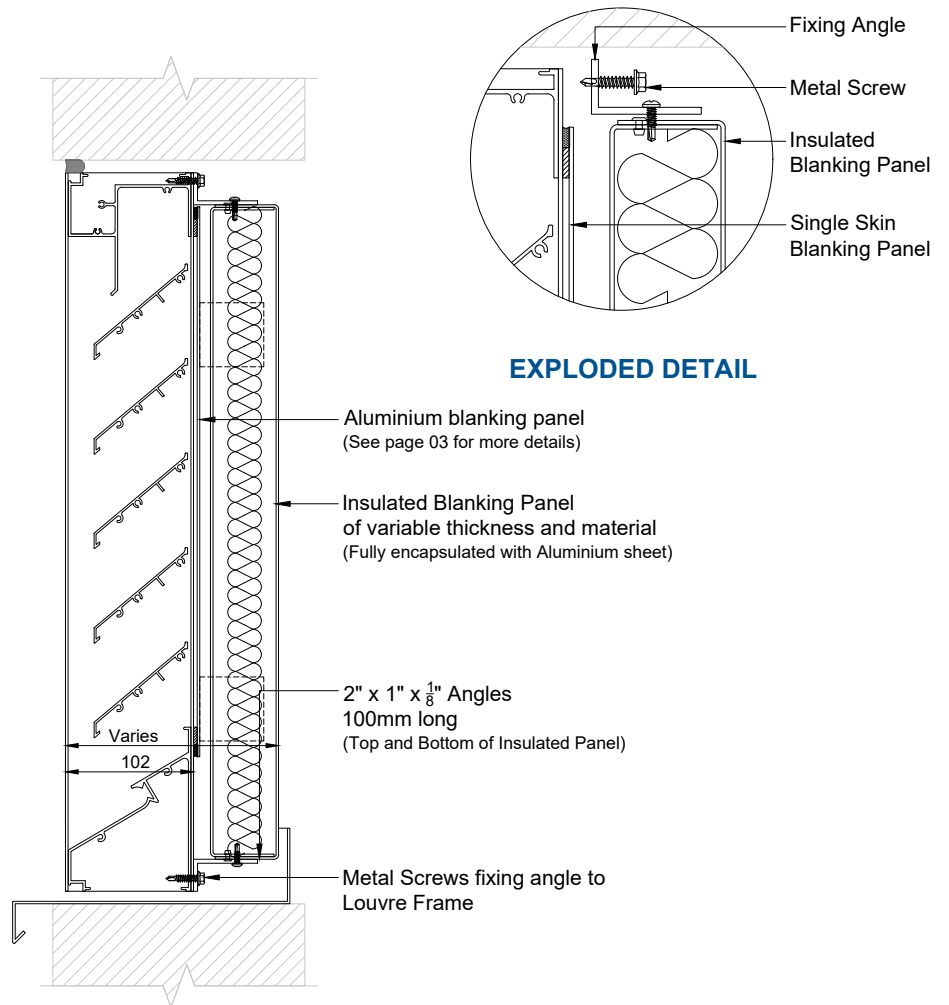

EXPLODED DETAIL

SECTION ON ELEVATION (1:6 @A4)

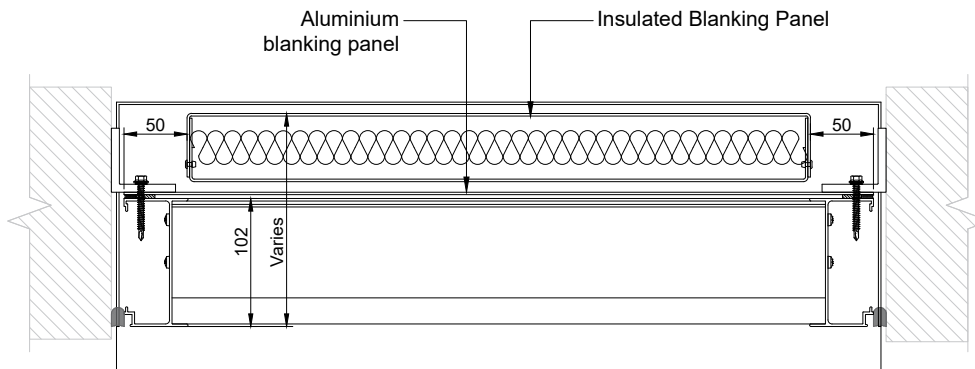

PLAN VIEW (1:6 @A4)

All dimensions in millimeters unless otherwise stated. Do not scale from the drawing.

HIDDEN MULLION DETAIL

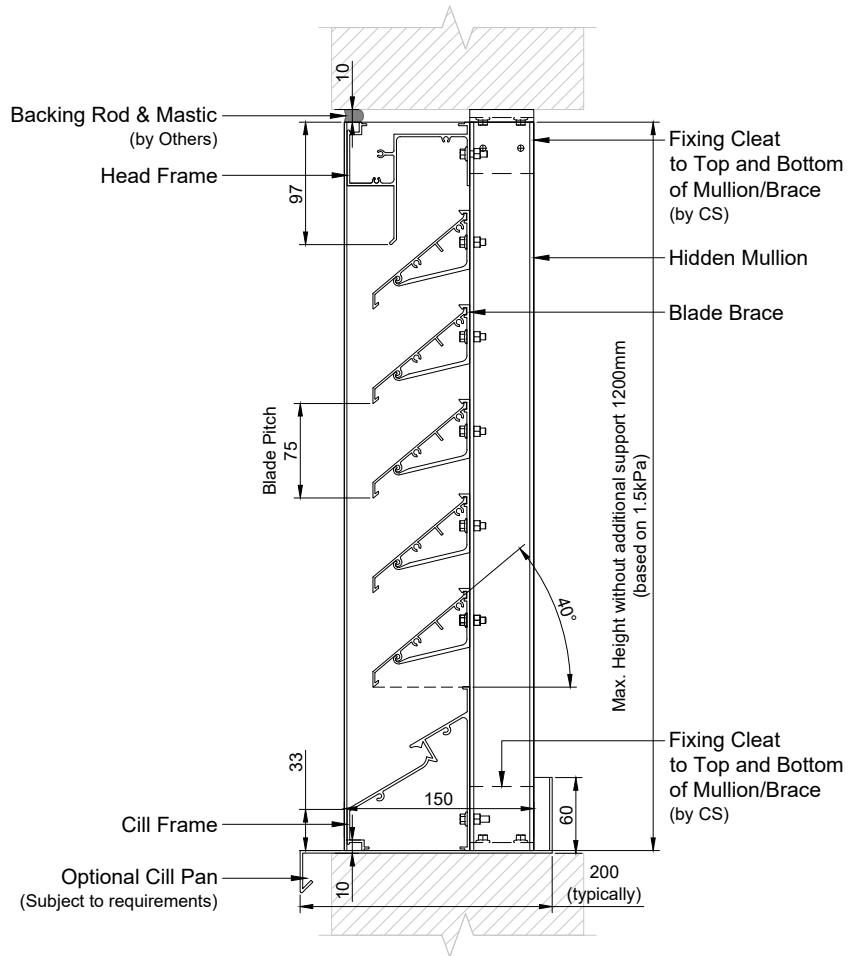

SECTION ON ELEVATION (1:6 @A4)

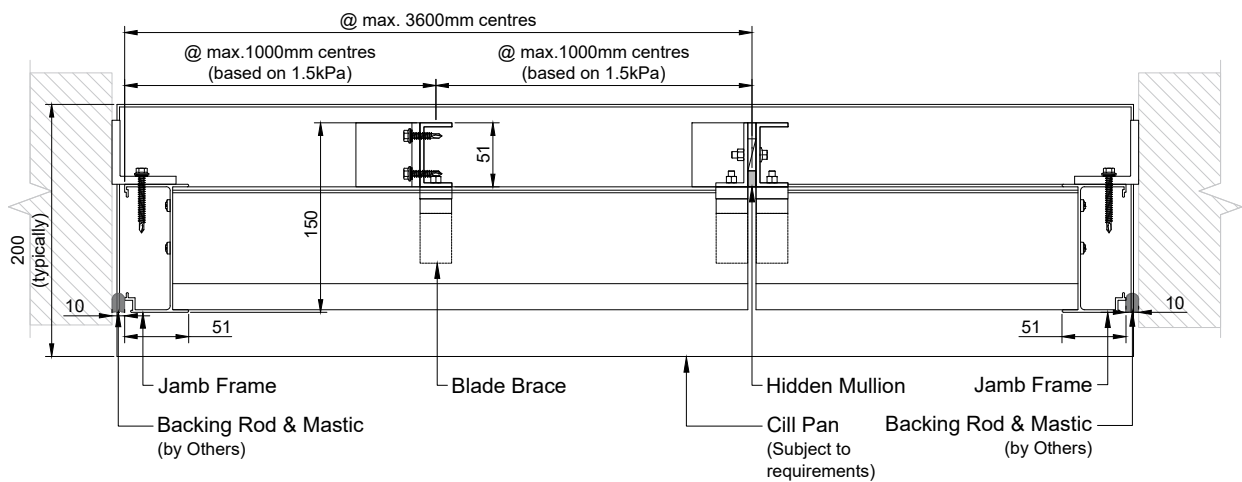

PLAN VIEW (1:6 @A4)

All dimensions in millimeters unless otherwise stated. Do not scale from the drawing.

25MM GLAZED-IN DETAIL

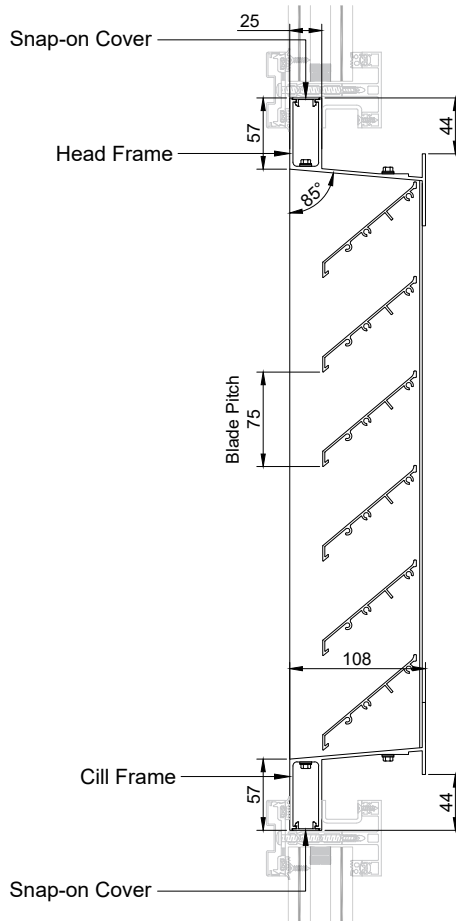

SECTION ON ELEVATION (1:6 @A4)

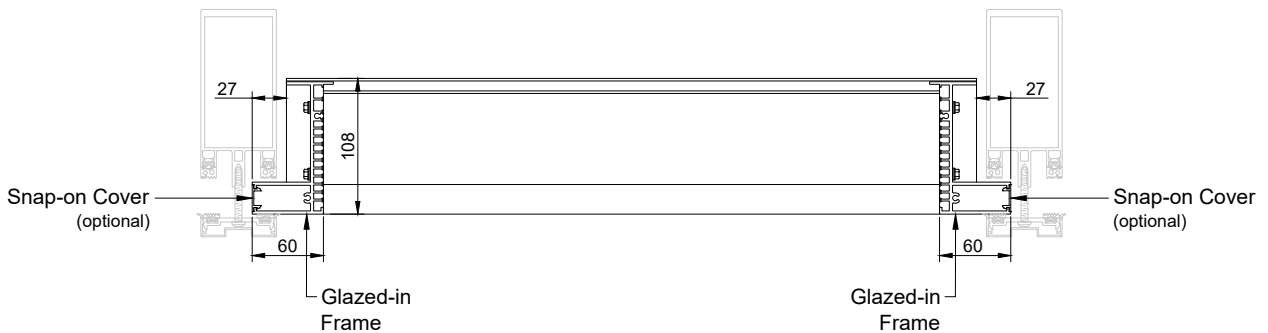

PLAN VIEW (1:6 @A4)

NOTE: Glazed-in louvres are supplied with Black Dowsil 791 Weatherproofing Silicone Sealant applied to seal all fixings and joints around the perimeter frame at the rear.

All dimensions in millimeters unless otherwise stated. Do not scale from the drawing.

25MM GLAZED-IN DETAIL

With Insect Mesh or Bird Guard

INSECT MESH

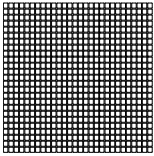

Fiberglass Mesh
Black PVC coated
(1:2 @A4)
LV-1008
72% Free Area

BIRD/ VERMIN GUARDS

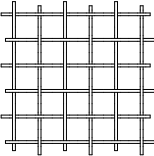

Galvanized Welded Mesh - (Standard)
(1:4 @A4)
LV-1408
85% Free Area

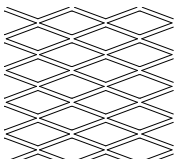

Flattened Aluminium
38-85AF - (Option)
(1:4 @A4)
LV-0158
73% Free Area

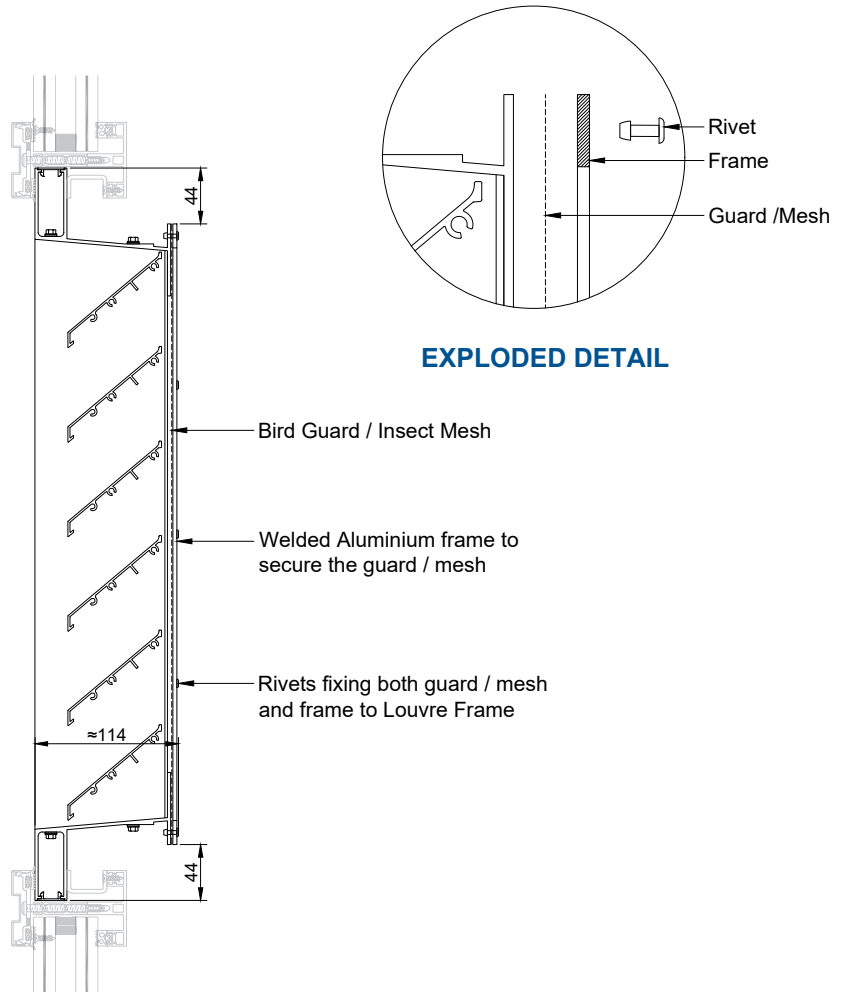

EXPLODED DETAIL

SECTION ON ELEVATION (1:6 @A4)

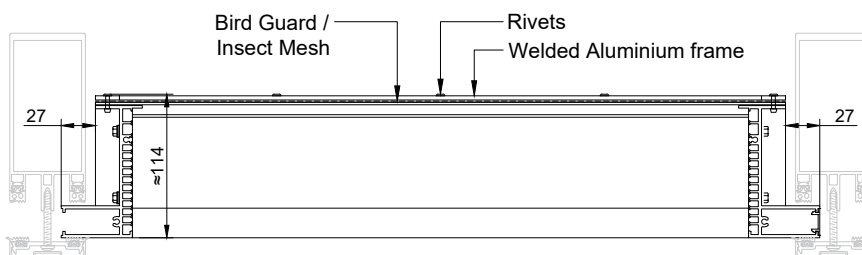

PLAN VIEW (1:6 @A4)

NOTE: Glazed-in louvres are supplied with Black Dowsil 791 Weatherproofing Silicone Sealant applied to seal all fixings and joints around the perimeter frame at the rear.

All dimensions in millimeters unless otherwise stated. Do not scale from the drawing.

Ventilation Louvres

A-3200 | Technical Datasheet

25MM GLAZED-IN DETAIL

With Single Skin Blanking Panel

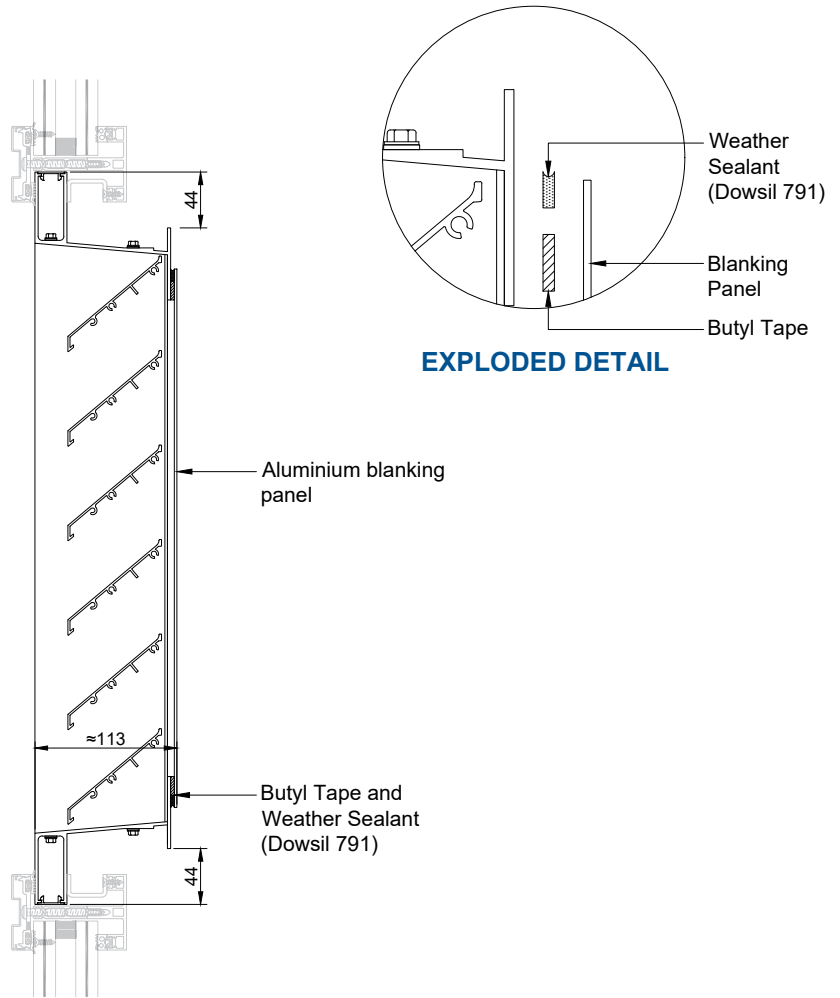

SECTION ON ELEVATION (1:6 @A4)

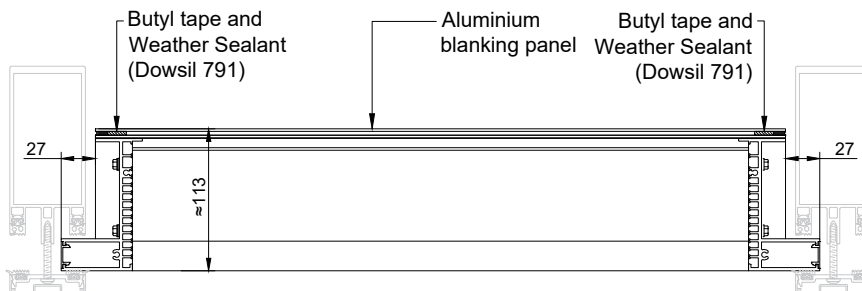

PLAN VIEW (1:6 @A4)

NOTE: Glazed-in louvres are supplied with Black Dowsil 791 Weatherproofing Silicone Sealant applied to seal all fixings and joints around the perimeter frame at the rear.

All dimensions in millimeters unless otherwise stated. Do not scale from the drawing.

Ventilation Louvres

A-3200 | Technical Datasheet

25MM GLAZED-IN DETAIL

With Insulated Blanking Panel

NOTE:

Insulation material options include:

- Non-combustible, A1 classified (to EN 13501-1) high strength stone wool core faced with open filament net
- Extruded polystyrene core

Panel thicknesses will vary, depending on the chosen core type and project's insulation requirements.

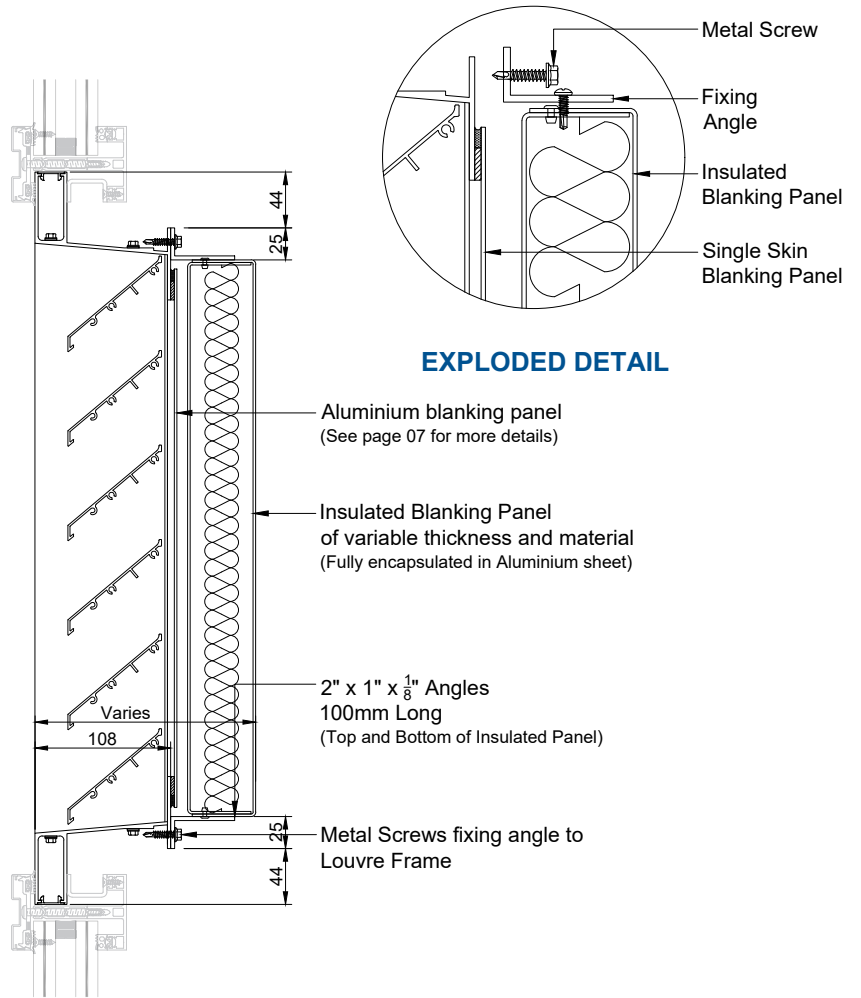

SECTION ON ELEVATION (1:6 @A4)

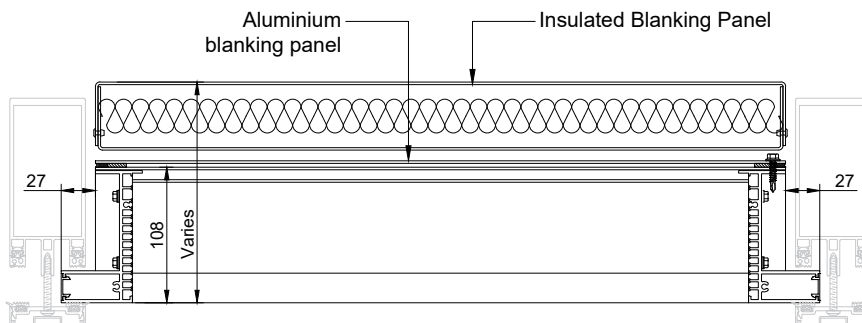

NOTE: Glazed-in louvres are supplied with Black Dowsil 791 Weatherproofing Silicone Sealant applied to seal all fixings and joints around the perimeter frame at the rear.

All dimensions in millimeters unless otherwise stated. Do not scale from the drawing.

Ventilation Louvres

A-3200 | Technical Datasheet

APPENDIX A - FREE AREA

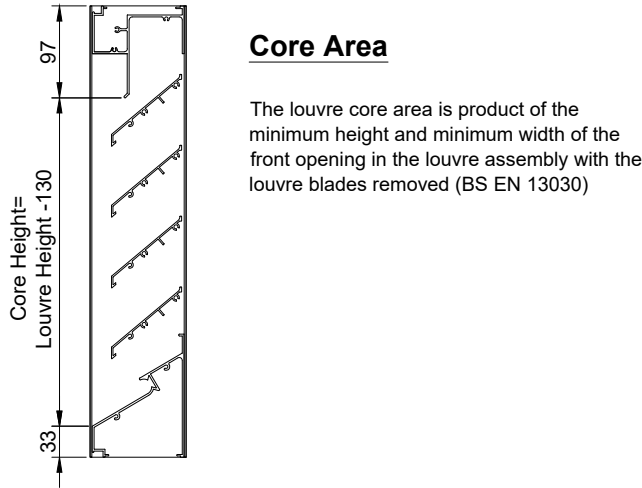

Free Area Between Blades

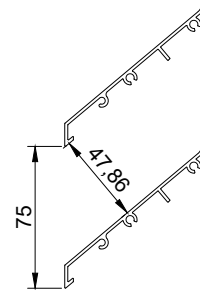

The percentage free area between the blades is calculated by taking the narrowest gap between the blades and dividing it by the blade pitch.

$$47.86/75 = 63.8\%$$

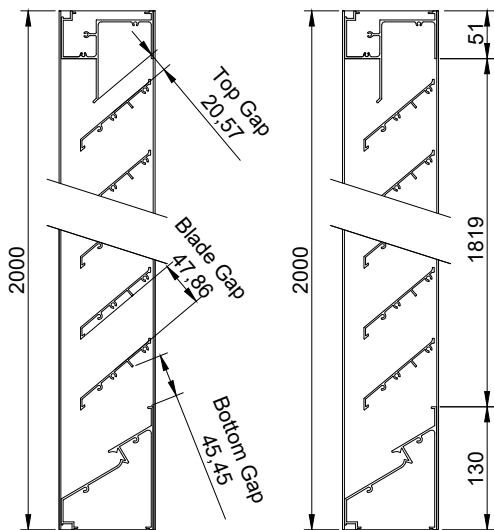
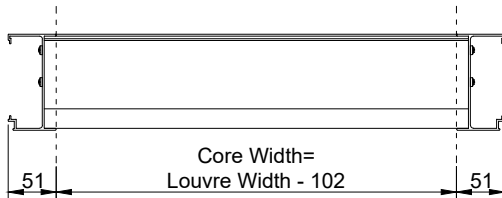

Free Area

Total free area is determined by multiplying the sum of the minimum distance between intermediate blades, top blade and head, and bottom blade and cill, by the minimum distance between jambs.

Percentage free area is calculated by dividing the total free area by the overall louvre size.

Example based on 2m x 2m louvre

- No. of blades - 24
- A - No. of gaps between blades - 23
- B - Top gap - 20.57mm
- C - Blade gap - 47.86mm
- D - Bottom gap - 45.45mm
- E - Width between jambs - 1898mm

Total Free Area

$$((B + (C \times A) + D) \times E)$$

$$((0.02057 + (0.04786 \times 23) + 0.04545) \times 1.898 = 2.215\text{m}^2$$

Percentage Free Area

$$2.215/4 = 55.4\%$$

Approximate Free Area

Total Free Area

Opening at rear of louvre x percentage free area between blades

$$1.819 \times 1.898 \times 63.8\% = 2.203\text{m}^2$$

Percentage Free Area

$$2.203/4 = 55.1\%$$

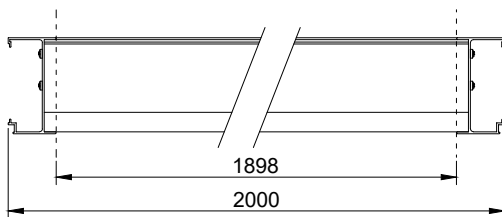

All dimensions in millimeters unless otherwise stated. Do not scale from the drawing.